

LONGER

WT3000-1FA Gear Pump Drive

WT3000-1FA
Micro Gear Pump Drive
Operating Manual

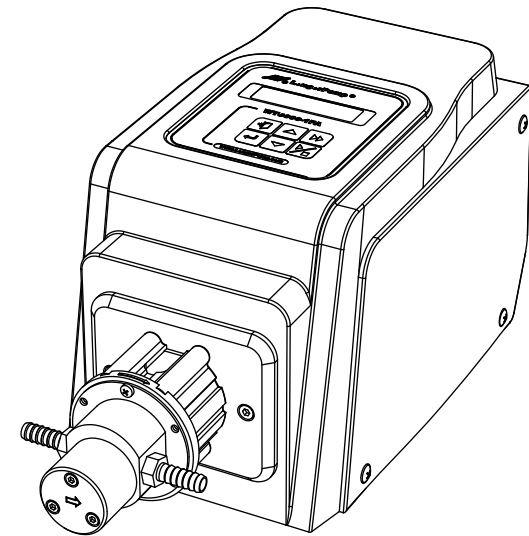

LONGER

Baoding Longer Precision Pump Co., Ltd.

Add: 3rd/4th Floor, Building 6B, University Science Park
Baoding National, High - Tech Industrial Development Zone
Baoding, Hebei, China 071051
Tel: 86 - 312 - 3110087 3138553
Fax: 86 - 312 - 3168553
E - mail: longer@longerpump.com
Http://www.longerpump.com

Baoding Longer Precision Pump Co., Ltd.

A Halma company

⚠ Important Information:

Please read operating manual carefully before operation.

⚠ Warning:

- To prevent damage to pump, do not run the pump dry.
- If the power line or the plug are worn or damaged please pull out the plug (Hold the plug not the power line when pulling out).
- Please shut down the power supply and pull out the plug when you think the pump needs to be maintained or repaired.
- Shut down the power supply of the pump when connecting to external control equipment.
- The International Protection rating of this pump is IP31. Do not let liquid enter this pump drive.

Warranty:

- The warranty period of this product is one year. If repair or adjustment is necessary within the warranty period, the problem will be corrected at no charge if it is not due to misuse or abuse on your part, as determined by the manufacturer. Repair costs out side the warranty period, or those resulting from product misuse or abuse, may be invoiced to you.
- Contact Longer Company or Longer’s dealers before returning pump to repair.
- Adopt original carton or reliable package when returning pump to repair.
- Write a note on detailed description of failure phenomena and contact information and put this note along with pump before returning pump to repair.

Table of Contents

Instruction-----1

Operating Panel-----2

Basic Operation-----2

Working Interface-----3

Menu Navigation Diagram-----5

Pump Head Operation-----5

 Pump Head Installation-----5

 Pump Heads and Flow rates -----5

 Pump Head Setting-----6

Flow Mode Operation-----6

 Enter Flow Mode-----6

 Flow Setting-----6

 Flow Calibration-----6

 Flow Mode Operation Procedure-----7

Dispensing Mode Operation-----7

 Enter Dispensing Mode-----7

 Dispensing Volume-----7

 Copy No. -----8

 Flow Setting-----8

 Pause Time-----8

 Dispensing Calibration-----9

 Dispensing Mode Operation Procedure-----9

External Control-----10

 External Enable Setting-----10

 Analog Signal Control-----10

 Footswitch Control-----11

 Communication Control Mode-----12

 External Control Output-----13

 Maintenance-----13

 Technical Specifications-----13

Instruction

WT3000-1FA micro gear pump has two kinds of work mode of flow mode and dispensing mode, it can deliver flow rates from 85.7 to 2571.4 ml/min and dispense volume from 0.1 ml to 999 liters. WT300-1FA adopts 128 × 32 LCD to display all kinds of information and parameters, it is suitable for deliver high temperature and high pressure liquid.

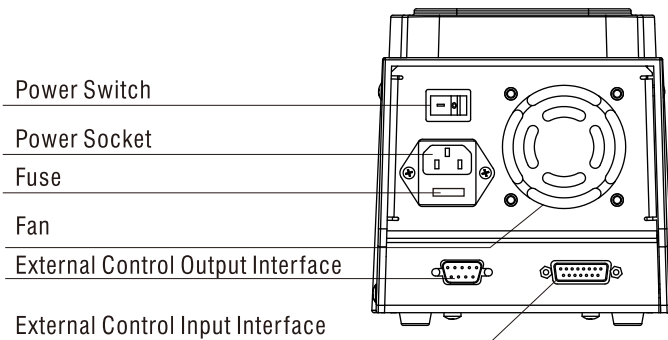
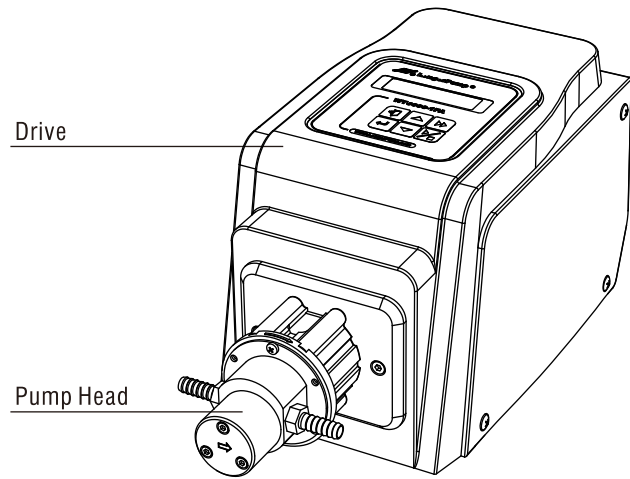

Reference:
Refer to page 10 to know the functions of External Control.

Operating Panel

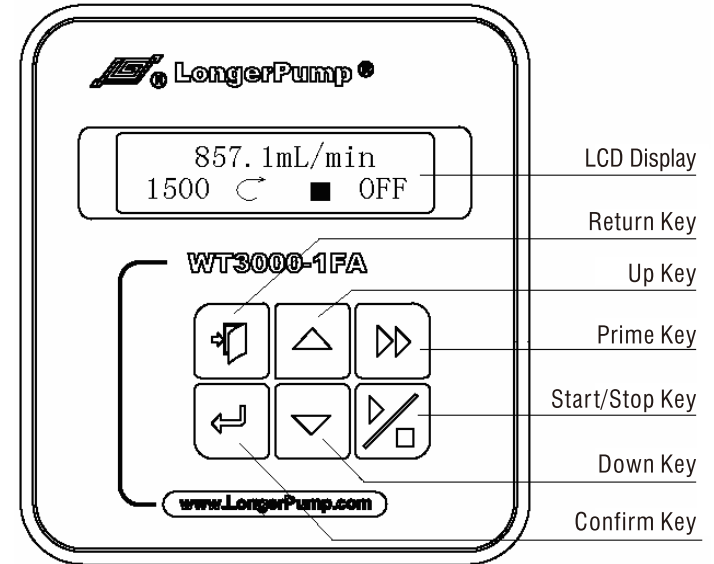

Basic Operation

- **Start/Stop Key**
Press Start/Stop key to stop or run the pump.
- **Prime Key**
In flow mode, press **Prime Key**, pump will run at max. Speeds; in dispensing mode, press **Prime Key**, pump will run at max. speed to accomplish the operation of fast filling or fast emptying; press **Prime Key** again, the pump will return to previous state. In prime state, all the other keys are invalid.
- **Up Key/Down Key**
Function 1: In flow mode, press **Up Key/Down Key** to adjust flowrates (it is invalid in priming mode).
Function 2: Mode selection function, press **Up Key/Down Key** to select submenu.
Function 3: Using for correcting, setting parameters and functions, such as dispensing volume, testing time, measured volume, copy No, footswitch, etc.

• **Confirm Key**

Press **Confirm Key** to confirm the setting of entering menu, parameters selection.

• **Return Key**

Function 1: Cancel current setting, return to previous menu.

Function 2: In dispensing mode, press Return Key to review the current speed and the time for dispensing a target volume.

Working Interface

- There is a option of Language Selection, users can select suitable language by pressing Up Key/Down Key after power on the pump.
- Display working interface after initializing the pump.

❖ **Flow rates display**

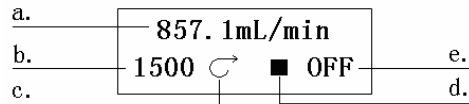

Instruction

- Current flow rate: In non priming mode, press Up Key/Down Key to adjust the flow rate.
- Current speed: Display current rpm, it will change when adjusting flow rates.
- Direction: Instructed the machine running direction, the direction could not be changed.
- Running status: **▶** means the pump runs; **■** means the pump stops; **▶▶** means the pump is in prime state.
- Control Mode: **INT** means the pump is controlled internally; **V** means the pump is controlled by external analog voltage signal; **mA** means the pump is controlled by external analog current signal; **Hz** means the pump is controlled by external 0-10 kHz pulse signal. **Off** means shutting off the external control function by setting menu.

❖ **Dispensing Display**

Dispensing status can be displayed in two interfaces (see illustration below), these two interfaces can be switched by pressing **Return Key**.

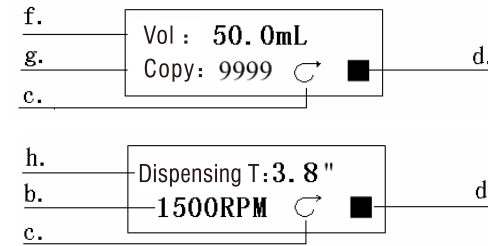

- Current speed: Display current rpm, it will change when adjusting dispensing volume or flow rates.
- Direction: Instructed the machine running direction, the direction could not be changed.
- Running status: **▶** means the pump runs; **■** means the pump stops; **▶▶** means the pump is in prime state.
- Dispensing volume: Display the dispensing volume.
- Copy: Display the copy number in dispensing mode.
- Dispensing time: Display the dispensing time. When the dispensing procedure starts, the dispensing time will be counted down. Adjust the flow rates or dispensing volume to change the dispensing time in dispensing parameters setting interface.

Menu Navigation Diagram

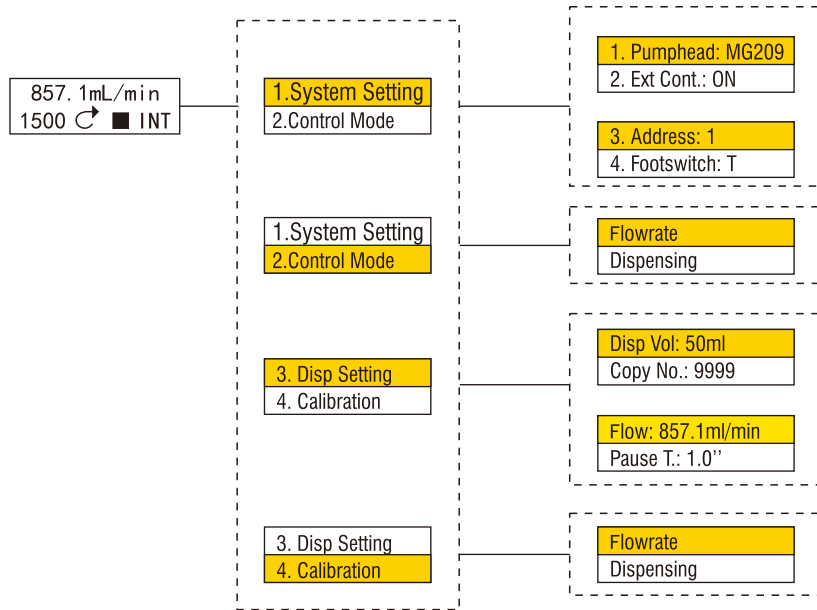

Pump Head Operation

❖ Pump Head Installation

The pump head is mounted on drive before the pump leaves the factory. Follow below procedure for changing another pump head.

1. Loose the three M3 screws which connect the pump head and the pump head bracket. Dismantle the pump head slightly.
2. Put the new pump head in the old pump head location. Pay attention to the inlet and outlet locations of the pump head. Use three M3 screws to connect the pump head and the pump head bracket.

Turn off the power supply before changing the pump head.

❖ Pump Heads and Flow rates

Acceptable Pump Heads	Product Code	Flow Rates (ml/min) 300-3000 (rpm)
MG204	05015010001	85.7 – 857.1 mL/min
MG209	05015010002	171.4 – 1714.3mL/min
MG213	05015010003	257.1 – 2571.4mL/min

❖ Pump Head Setting

Press **Confirm Key** to enter Pump head interface, press Up Key or Down Key to select suitable pump head and then press **Confirm Key** to save the setting or press **Return Key** to cancel the setting and return to previous menu.

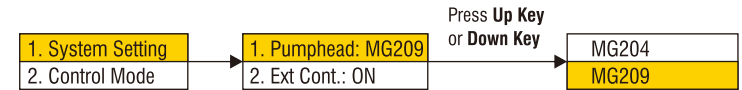

Flow Mode Operation

❖ **Enter Flow Mode:** Press **Control Mode** to enter next interface, press **Up Key** or **Down Key** to select **Flowrate**, press **Confirm Key** to save or press **Return Key** to cancel the setting and return to previous menu.



❖ **Flow Setting:** In **Flowrate** mode, press **Up Key** or **Down Key** to adjust the flow rates of pump.

❖ Flow Calibration

- See below diagram, enter **Calibration** interface, press **Up Key** or **Down Key** to set the testing time, the range of testing range is from 30 to 1800 seconds, press **Confirm Key** to save the setting or press **Return Key** to cancel the setting and back to previous menu after select a certain testing time value.
- The pump will display the running time and actual volume after pressing **Start/Stop Key** to start the calibration of pump. Running time will count down until testing time is over. Press **Up Key** or **Down Key** to input measured volume, press **Confirm Key** to save the setting. The calibration operation can be repeated.

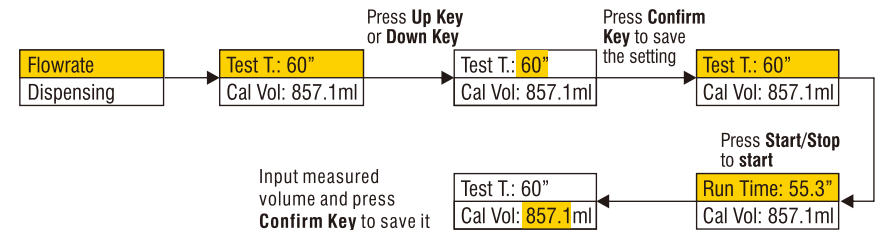

- If the actual volume is known in advance, enter the calibration interface and input the actual volume directly.



❖ **Flow Mode Operation Procedure**

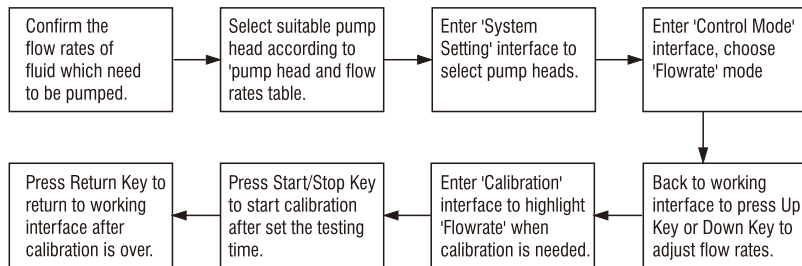

Dispensing Mode Operation

💡 It is recommended installing a one-way valve to prevent liquid reflux which will affect the accuracy of dispensing volume before starting dispensing mode.

- ❖ **Enter Dispensing Mode:** Press **Confirm Key** to enter Control Mode interface, press **Up Key** or **Down Key** to select work mode, press **Confirm Key** to save the setting or press **Return Key** to cancel the setting and return to previous interface.



- ❖ **Dispensing Volume:** The volume to be dispensed between two time intervals.
- Enter Dispensing Setting interface, press **Up Key** or **Down Key** to set dispensing volume, press **Confirm Key** to save the setting or press **Return Key** to cancel the setting and return to previous interface.
- Running time will be changed corresponding to the changing of dispensing volume.

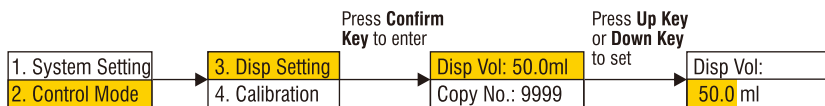

- ❖ **Copy No.:** The dispensing times are from 0 to 9999 times in Dispensing work mode.
- Enter Dispensing interface, press **Up Key** or **Down Key** to set the copy number, press **Confirm Key** to save the setting or press **Return Key** to cancel the setting and back to previous interface.
- If set Copy Number to Zero, dispensing cycles will be an infinite loop approach to work.

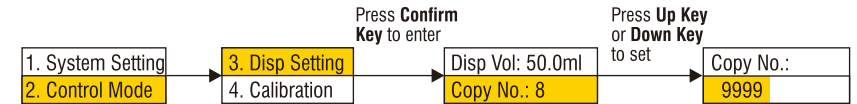

- ❖ **Flow Setting:** The flow rates mean the flow rates in dispensing mode, the running time will be changed when adjusting the flow rates.
- Enter Flow rates interface, press **Up Key** or **Down Key** to set the flow rates, press **Confirm Key** to save the setting or press **Return Key** to cancel the setting and back to previous interface.

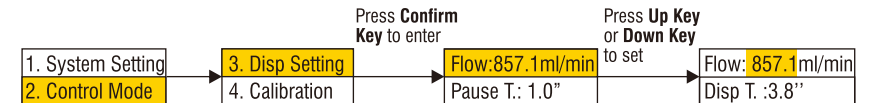

- ❖ **Pause Time:** The Pause time between two dispensing cycles.
- Enter Pause Time interface, press **Up Key** or **Down Key** to set the pause time, press **Confirm Key** to save the setting or press **Return Key** to cancel the setting and back to the previous interface.

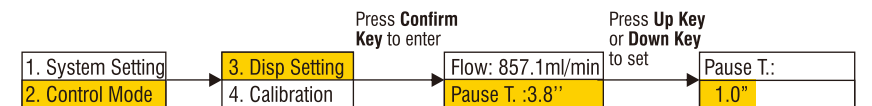

❖ **Dispensing Calibration:** The parameters can not be changed under dispensing calibration, the default parameters are the parameters of dispensing mode.

- Enter Dispensing Calibration interface.
- Press **Start/Stop Key** to start the Calibration, and then enter next interface to display the Running Time and Measured Volume, the running time will count down until the calibration is over.

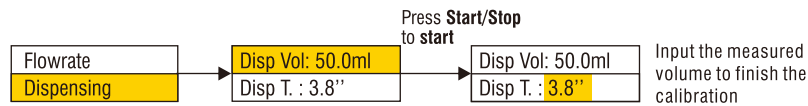

- If the measured volume is known in advance, user can input the measured volume directly using **Up Key** and **Down Key** in calibration interface. It is unnecessary to repeat above steps.

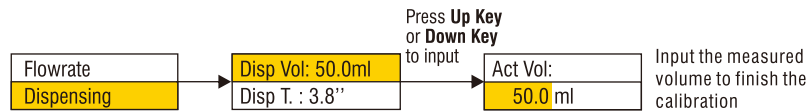

❖ **Dispensing Mode Operation Procedure**

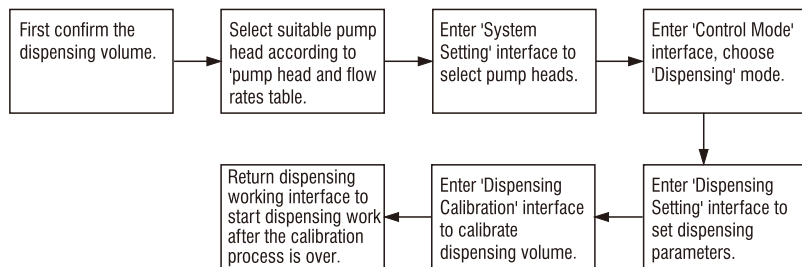

External Control

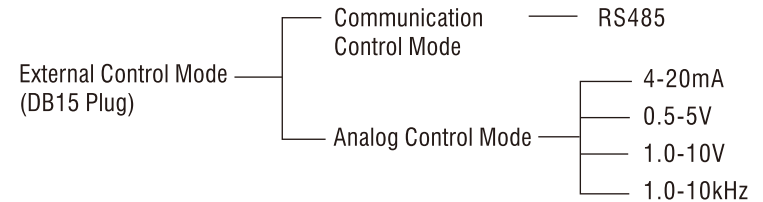

❖ **Analog Signal Control**

- Set 'Analog Signal Control' in enabling mode.
- 💡 Five kinds of external control module need to be ordered individually.

- Enter Flow rates interface, press **Up Key** or **Down Key** to set the flow rates, press **Confirm Key** to save the setting or press **Return Key** to cancel the setting and back to previous interface.

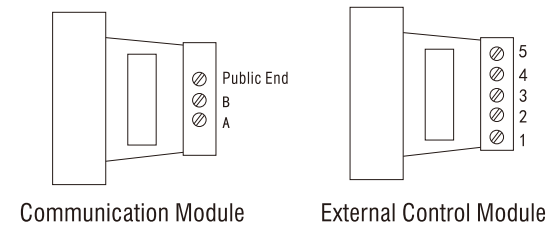

❖ **External Control Enable Setting**

- Setting External Control Enable
- Enter External Control Enable interface, press **Up Key** or **Down Key** to 'on' or 'off' the External Control, press **Confirm Key** to save the setting or press **Return Key** to cancel the setting and back to previous interface.



❖ **Terminal Definition of External Control Module**

- #1: Analog input in 4-20mA, 0.5-5V, 1.0-10V external control modules, control the speed of the pump. It is open in 1-10KHz external control module.
- #2: External control start/stop input, Open or input low level, the pump runs. Input high level, the pump stops.
- #3: Open

#4: Analog ground in 4-20mA, 0.5-5V, 1.0-10V external control modules; Pulse input end in pulse input external control module, control the speed of the pump.

#5: The COM of external control start/stop signal input; the COM of frequency input.

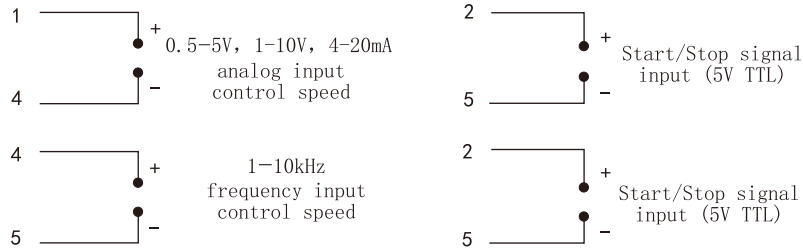

❖ Footswitch Control

- Footswitch connect to external control interface to control the Start/Stop of pump. It can be set in menu according to actual requirement.
- Footswitch has two kinds of work modes.

Trigger: Press footswitch, the pump starts running; press footswitch again, the pump stops.

Gated: The pump runs as long as the footswitch is pressed.

See below diagram, enter 'Footswitch' interface, press **Up Key** or **Down Key** to select suitable work mode, press **Up Key** or **Down Key** to select suitable work mode, press **Confirm Key** to save the setting or press **Return Key** to cancel the setting and back to previous interface.

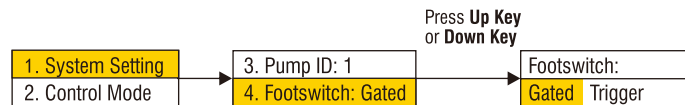

💡 Pump can automatically identify footswitch when a footswitch connected with a pump, in the meantime Start/Stop Key will be invalid. This status doesn't have any relation with external control enable setting.

💡 Footswitch need to be ordered individually. The suitable footswitch for this pump is JK-3.

❖ Communication Control Mode

- This pump can connect with upper computer (Computer, SCM, PLC) through RS485 serial communication module. Please contact Longer Company for communication protocol.
- Address Setting
A single upper computer can control up to 30 pumps when pumps are controlled by upper computer through RS485. Each pump must be assigned an individual address.
- Set the address
See below diagram, Enter 'pump ID' interface, press **Up Key** or **Down Key** to set pump ID (1-30), press **Confirm Key** or press **Return Key** to cancel the setting and back to previous interface.

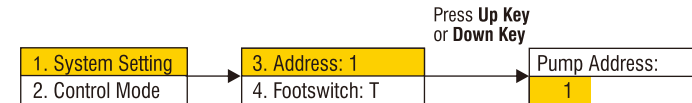

❖ External Control Output

Pump is equipped with output port in order to monitor the status of pump. Output signal adopts optoelectronic isolation circuit. A pull-up resistor and power supply are needed when using.

Terminals definition:

DB9-1: Start/Stop output, pump outputs low level when pump runs; pump outputs high level when pumps stops.

DB9-8: Frequency output, 300-3000 rpm corresponding to 1.25-12.5 KHz.

DB9-4,6,7: COM

Maintenance

The pump head and the surface of drive don't have chemical resistance to organic solution and high corrosive liquid, so the pump head and the surface of drive should be keep dry and clean or pump life will be shortened.

Technical Specifications

❖ **Main Functions**

Suitable Pump Heads	MG204, MG209, MG213
Operating Mode	Membrane keypad to set parameters and control the pump
Prime Function	Fast filling, cleaning and emptying
Display Function	128×32 LCD display all the information
External Control Input	Control flow rates and start/stop of the pump in flow mode
Footswitch	Control the start/stop of pump
External Control Output	Output the signals of Start/Stop and speed
Communication	Communicate with upper machine or computer
Flow Function	Deliver fluid as set flow rates
Dispensing Function	Set dispensing volume, copy number and pause time, etc
Memory Function	Store all the running information automatically
Calibration Function	Acquire higher accuracy
Cooling Function	Heat-emitting fan
Direction	Clockwise only

❖ **Specifications**

Flow Rates	85.7 to 2571.4 ml/min	
Dispensing Volume	0.1ml to 999 liters	
Copy No.	0-9999, zero means infinite cycle	
Pause Time	1 second to 999 hours, resolution is 0.1 second	
Flow Rate Calibration	30 seconds to 30 minutes, resolution is 1 second	
External Control	Input Function	4-20mA, 0.5-5V and 1.0-10V modules control flow rates, TTL control the Start/Stop of the pump
	Output Function	Output the status of Start/Stop and 1.25-12.5kHz corresponding to 300-3000 rpm under the optical isolation mode
	Communication	RS485
Liquid to be pumped	The diameter of particle in liquid is smaller than 10μm	
Acceptable Liquid Temperature	PTFE: -45-50°C, PEEK:-45-120°C	
Maximum Outlet Pressure (Testing Medium: Water)	MG204: 1.4MPa	
	MG209: 0.9MPa	
	MG213: 0.8MPa	
Acceptable Liquid Viscosity	≤220cst	
Power Supply	AC220V or AC110V, 50Hz/60Hz	
Power Consumption	≤50W	
Operating Conditions	Temperature: 0-40°C, Relative Humidity: <90% (no dew)	
Drive Dimensions	232×142×149(mm) (L×W×H)	
Drive Weight	2.83kg	
IP Rating	IP31	

